

Wall and ceiling profiles

FB 20

High quality EPDM material

Hard wearing, temperature resistant (-30°C to +120°C)

Easy installation, secure fixing and good watertightness

by special design of the site barbs

High durability

due to excellent permanent elasticity of EPDM material

Excellent sound and thermal insulation

due to special cellular design of the profiles

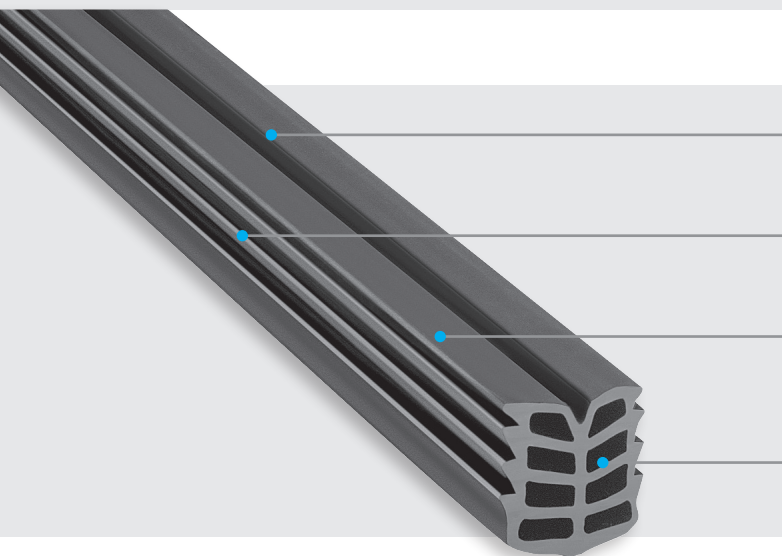

Profile	Nominal Joint width b_s [mm]	Depth of joint min. h_2 [mm]	Total movement [mm]
FB 20/1518	10	25	6
FB 20/1820	12	25	6
FB 20/2122	15	30	7
FB 20/2422	18	30	7
FB 20/3028	20	35	12
FB 20/4030	28	45	14
FB 20/5038	35	55	20
FB 20/6048	45	65	20

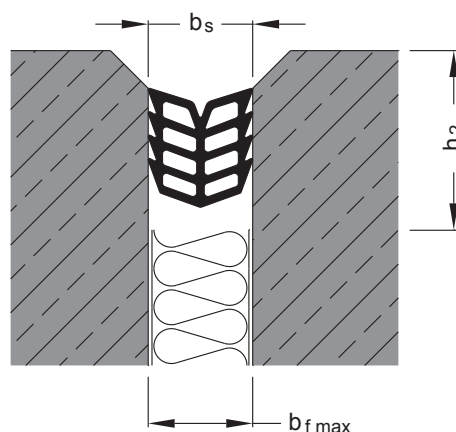

Standard colours: black, grey

Production length: 20 m

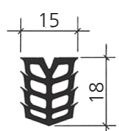

FB 20/1518

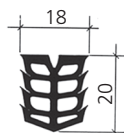

FB 20/1820

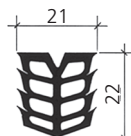

FB 20/2122

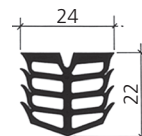

FB 20/2422

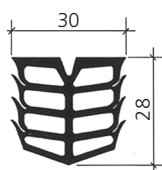

FB 20/3028

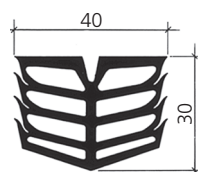

FB 20/4030

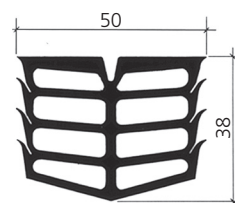

FB 20/5038

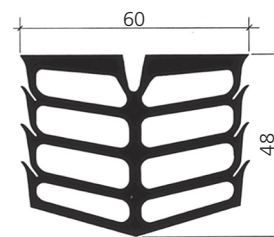

FB 20/6048